

Instructions for Sound Anchors 4 Post Monitor Stands

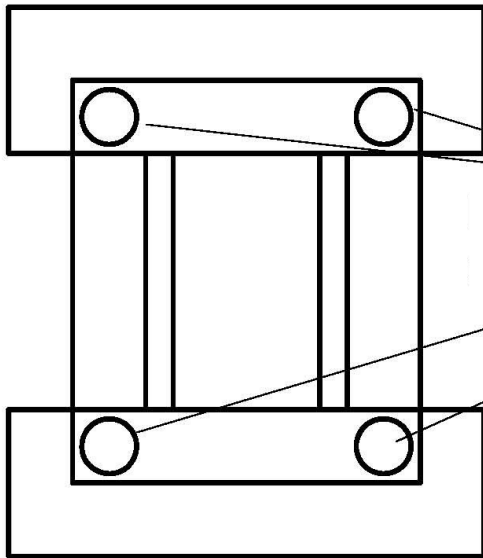

**Sound Anchors Inc.
2835 Kirby Circle
Palm Bay Florida 32905 USA.
info@soundanchors.com
www.soundanchors.com
Phone: (321) 724-1237**



Blue Dots
(Blue Sorbothane Pads)

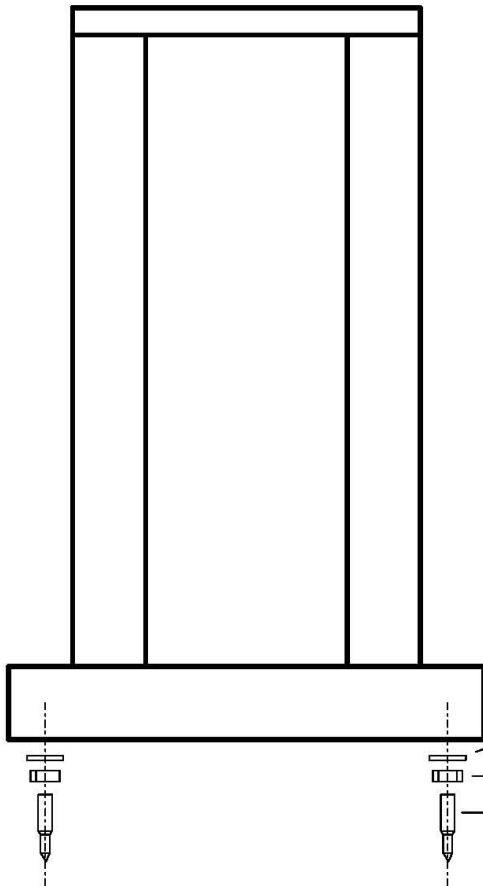

1. Mount spikes, jam nuts, and washers to the bottom of the stand.
2. Adjust the spikes to level the stand.
3. Place blue dots on the stand as shown.
4. Place speaker on top of the stand.

Washers
Jam Nuts
Spikes

Parts List

4 ea. Spikes

4 ea. 3/8-16 Jam Nuts

4 ea. 3/8 Flat Washers

4 ea. Blue Dots

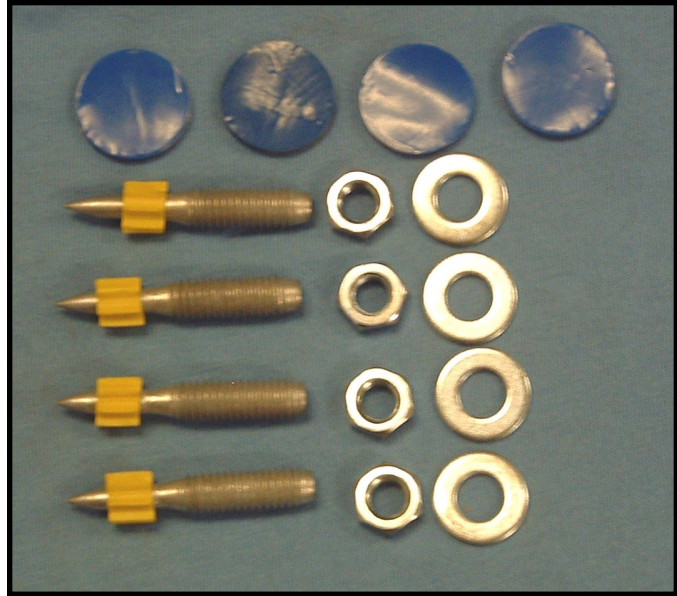

Optional

Conecoasters

Short Spikes

Our stands are spiked at the floor. If you are placing the stands on a wood or tile floor and are concerned about using the spikes that come with the stand we recommend using our Conecoasters. These stainless steel disks with Kevlar felt pads provide the benefits of using spikes while protecting the floor.

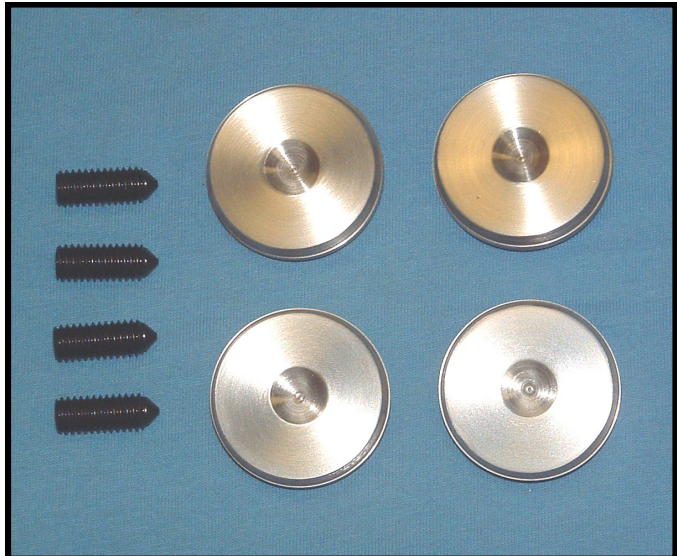

Black & Blue Dot Guidelines

Sound Anchors' Black & Blue Dots are made of urethane coated Sorbothane. Sorbothane is unique in that it absorbs motion in all directions making it an ideal isolation material between speakers and stands. Black & Blue Dots do not have adhesive on them. The blue side should be placed on the stand and the black side should be placed under the speaker. However, under the weight of the speaker and over time they will compress and become gummy and possibly discolor or mar the finish on the bottom of the speaker. Under certain conditions they may also adhere to the bottom of your speakers, causing difficulty in removing or repositioning the speaker. The urethane coating has been added to help alleviate this issue.

Care should be used when removing speakers from the stands as to avoid damaging the bottom of the speaker. It is recommended that a thin blade (i.e. putty knife) be slid in between the speaker and the platform to break the adhesion and dislodge the Black & Blue Dot. Black & Blue dots should not be used on speakers with a lacquer finish. These surfaces are highly susceptible to marring from use of the Black & Blue dots.

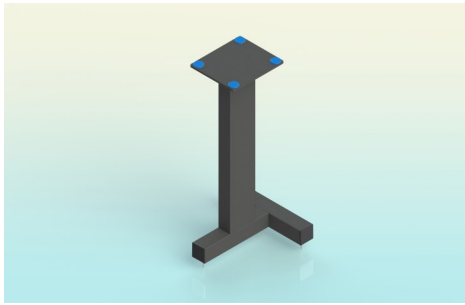

SINGLE POST STAND

Perfect stand for anyone setting up a value based system using small monitor loudspeakers. These stands offer Sound Anchor hi-performance with a massive look at a surprisingly low price.

Available in heights between 6" and 32"

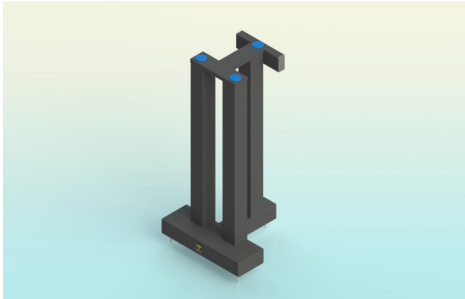

3 POST STAND

The music lovers stand. The Sound Anchor 3 post stand offers the best price to performance ratio for your monitors. Near reference performance for less money than a 4 Post stand.

Available in heights between 6" and 32"

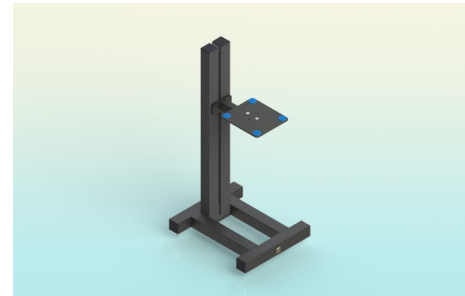

ADJH ADJUSTABLE HEIGHT AND TILT STAND

Reference performance from an Adjustable stand design for your loudspeakers. This stand is in use in hundreds of award winning studios for producing music, film, games and broadcast media.

Available in 6" to 32" and 6" to 44" ranges

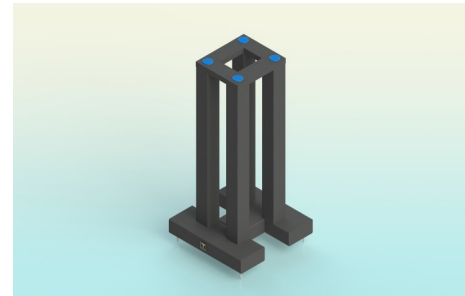

4 POST STAND

Reference performance and a balanced look for your hi-performance monitor speakers. This stand will allow you to hear all the subtle differences in your components and cables.

Available in heights between 6" and 32"

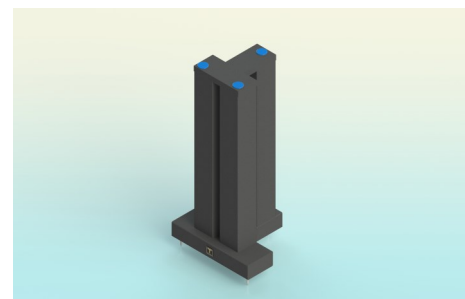

3 POST SIGNATURE STAND

Reference performance from a 3 post design for your favorite monitor loudspeakers. This stand looks way cool and will let you hear all the subtle differences in your components and cables.

Available in heights between 6" and 32"

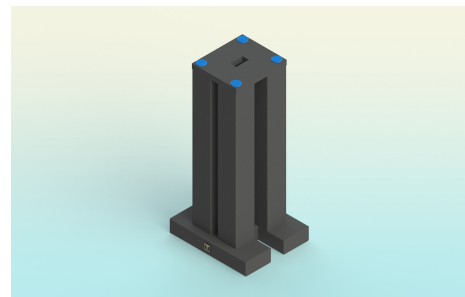

4 POST SIGNATURE STAND

Over the top reference performance and a super bold look for your loudspeakers. This is our best monitor stand period. It will out perform any other stand on the market today.

Available in heights between 6" and 32"

Sound Anchors Inc.
2835 Kirby Circle NE
Unit 110
Palm Bay, Florida 32905



Phone: 321 724 1237
Fax: 321 914 0953
E-mail:
info@soundanchors.com
www.soundanchors.com